

A (1:4)

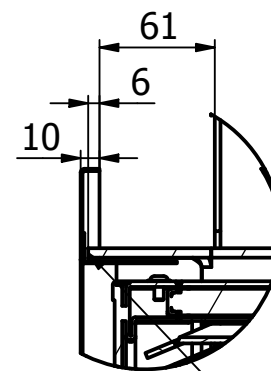

Zakończenie ramki drzwiczek.

Zakończenie ramki drzwiczek.

B (1:4)

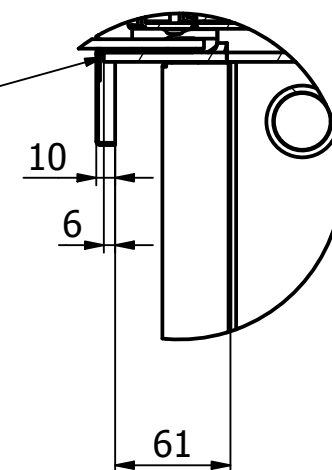

C (1:4)

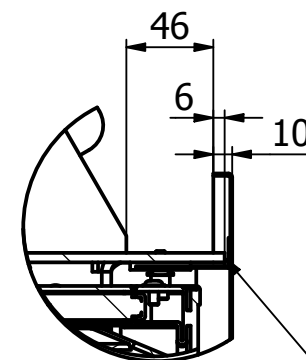

Zakończenie ramki drzwiczek.

Zakończenie ramki drzwiczek.

D (1:4)

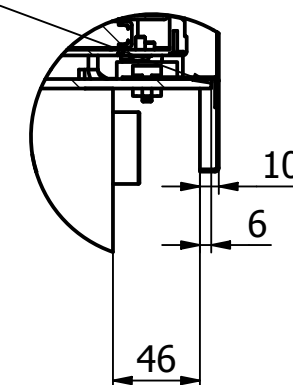

E (1:4)

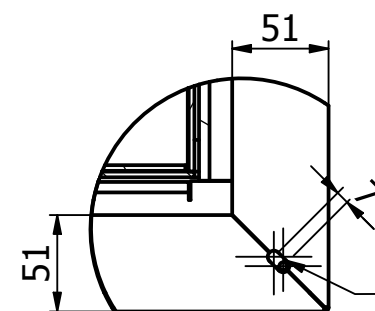

Możliwość regulacji.

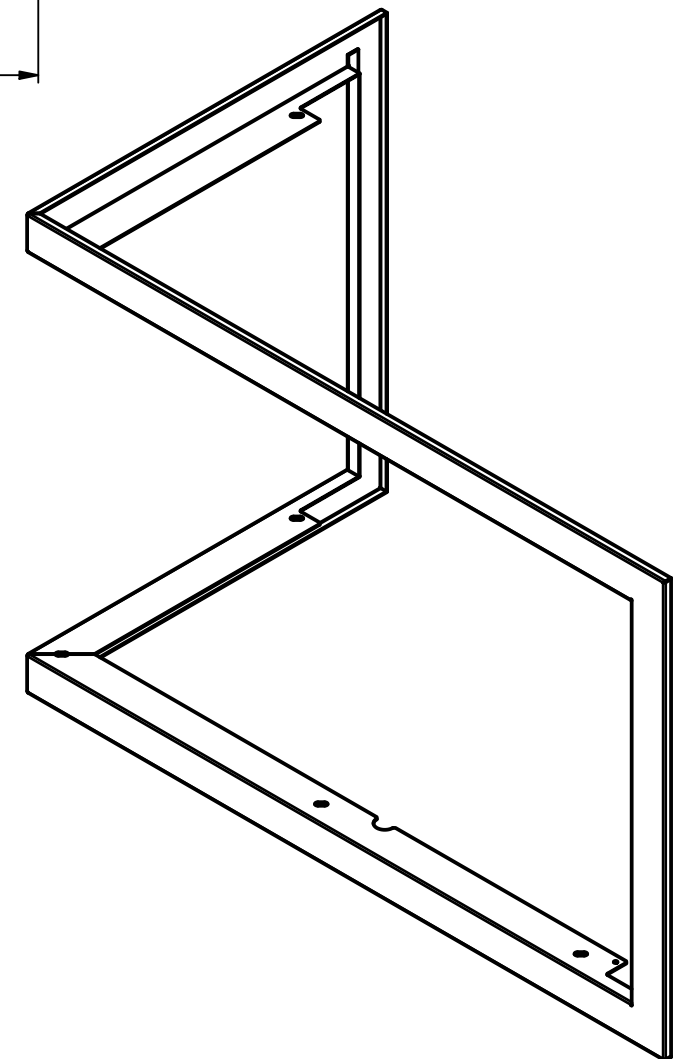
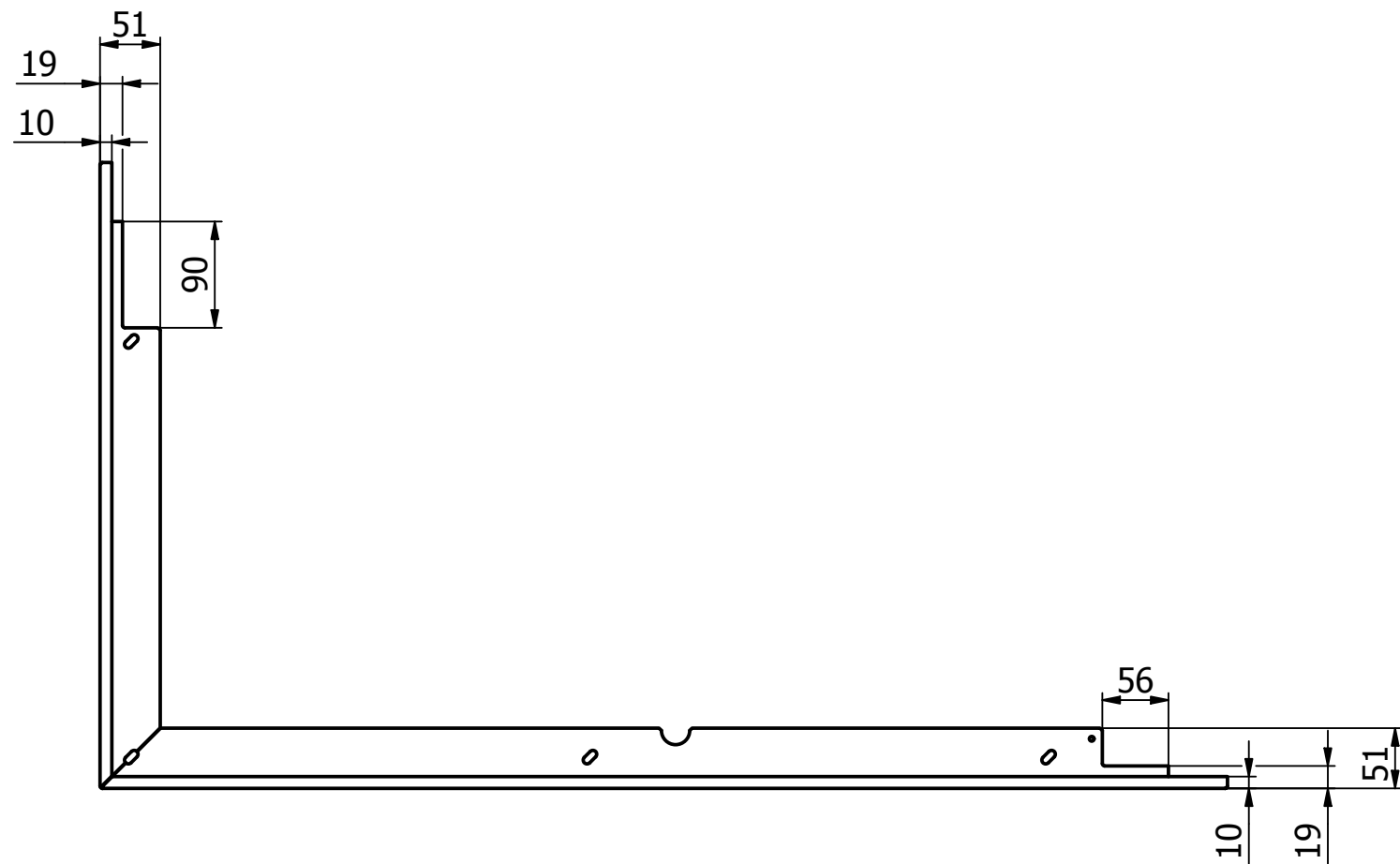
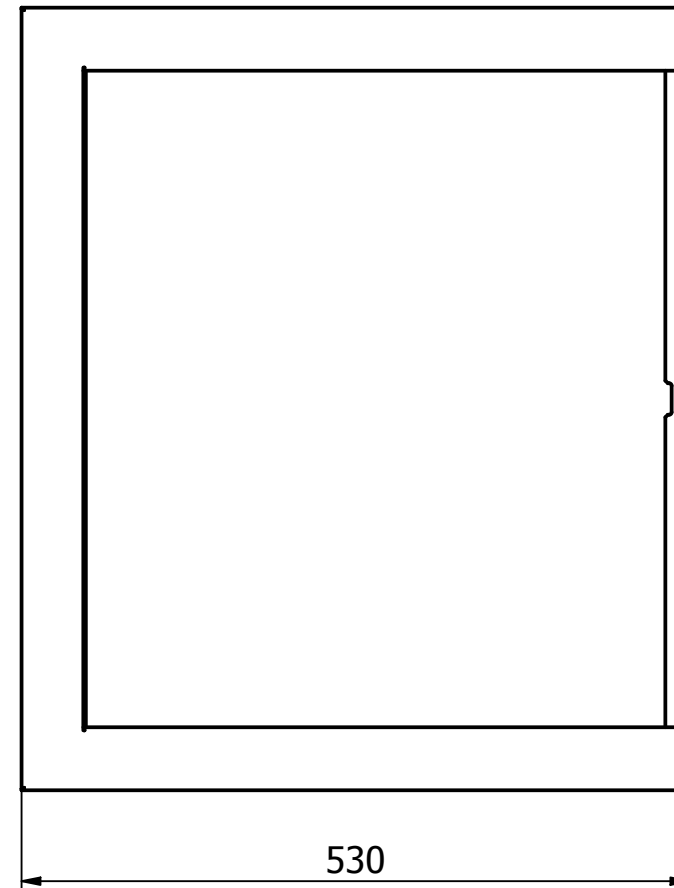
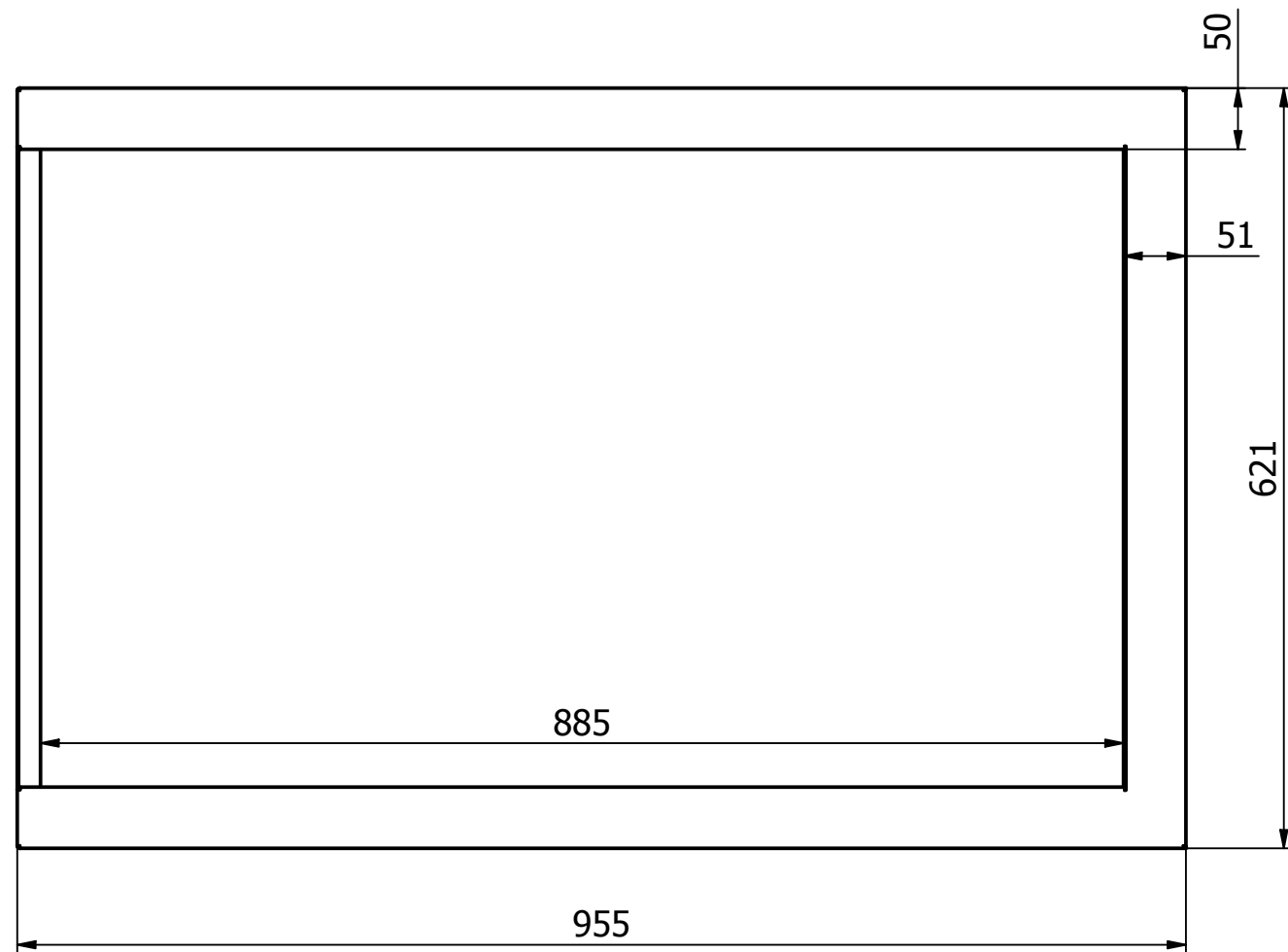

Maskownica 50 płytka